

329282

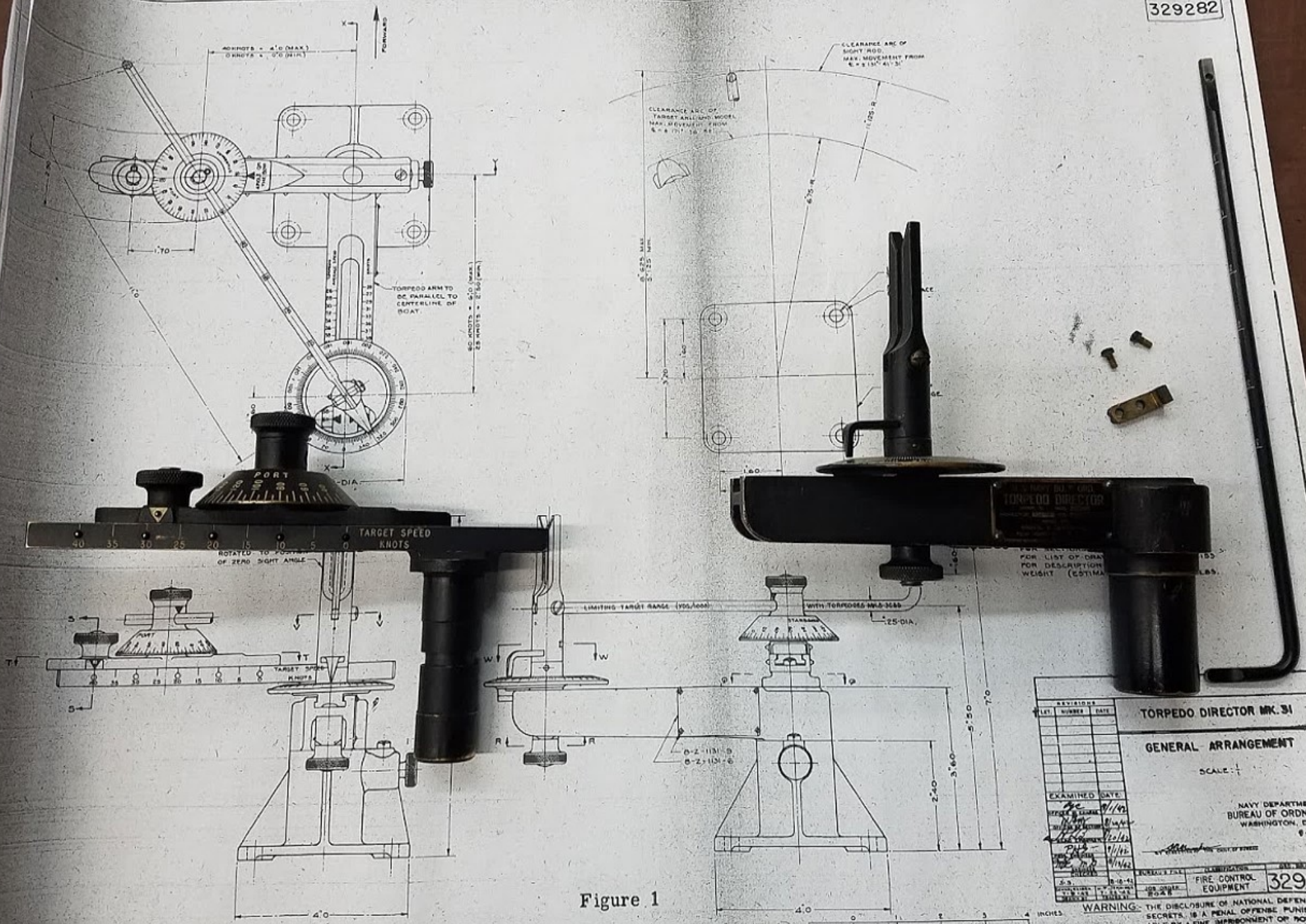

Figure 1

FOR LIST OF DRAWINGS FOR DESCRIPTION AND WEIGHT (ESTIMATE)

ASSIGNMENTS		TORPEDO DIRECTOR MK. 31	
LET.	NUMBER	DATE	
EXAMINED DATE:		GENERAL ARRANGEMENT	
BY:		SCALE: 1/2"	
CHECKED:		NAVY DEPARTMENT	
APPROVED:		BUREAU OF ORDNANCE	
		WASHINGTON, D. C.	
		6-A-1942	
		BY: [Signature] CHIEF, OFFICE	
BUREAU FILE:		CLASSIFICATION:	
JOB ORDER:		FIRE CONTROL EQUIPMENT	
REVISION:		329282	

WARNING: THE DISCLOSURE OF NATIONAL DEFENSE SECRETS IS A PENAL OFFENSE PUNISHABLE BY A FINE, IMPRISONMENT OR BOTH.



CO 2625

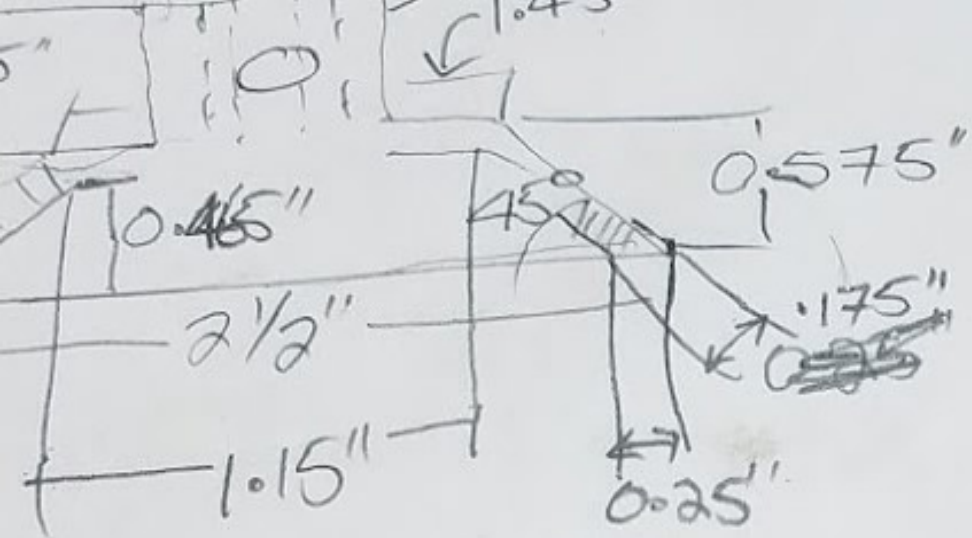

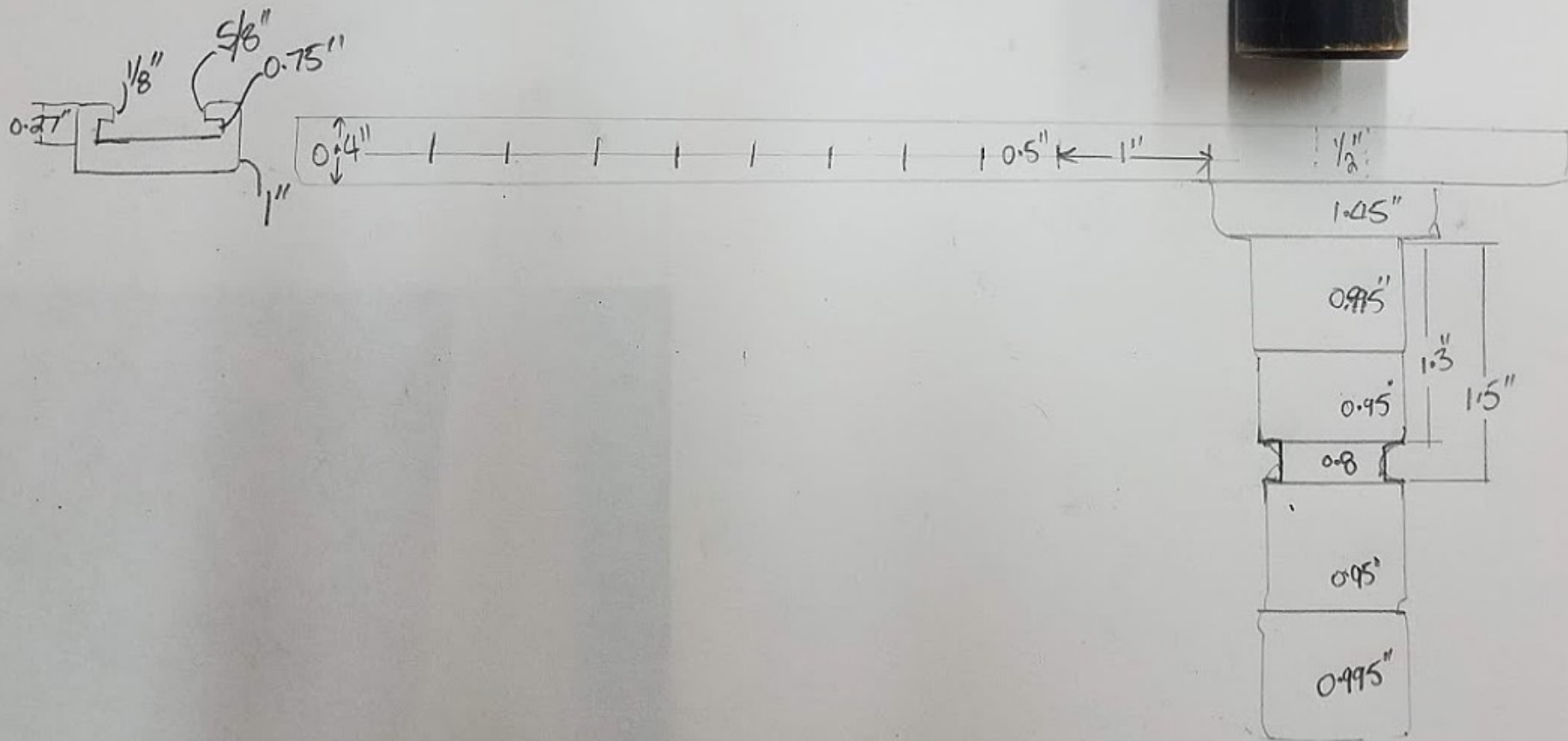

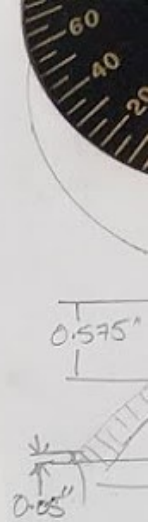
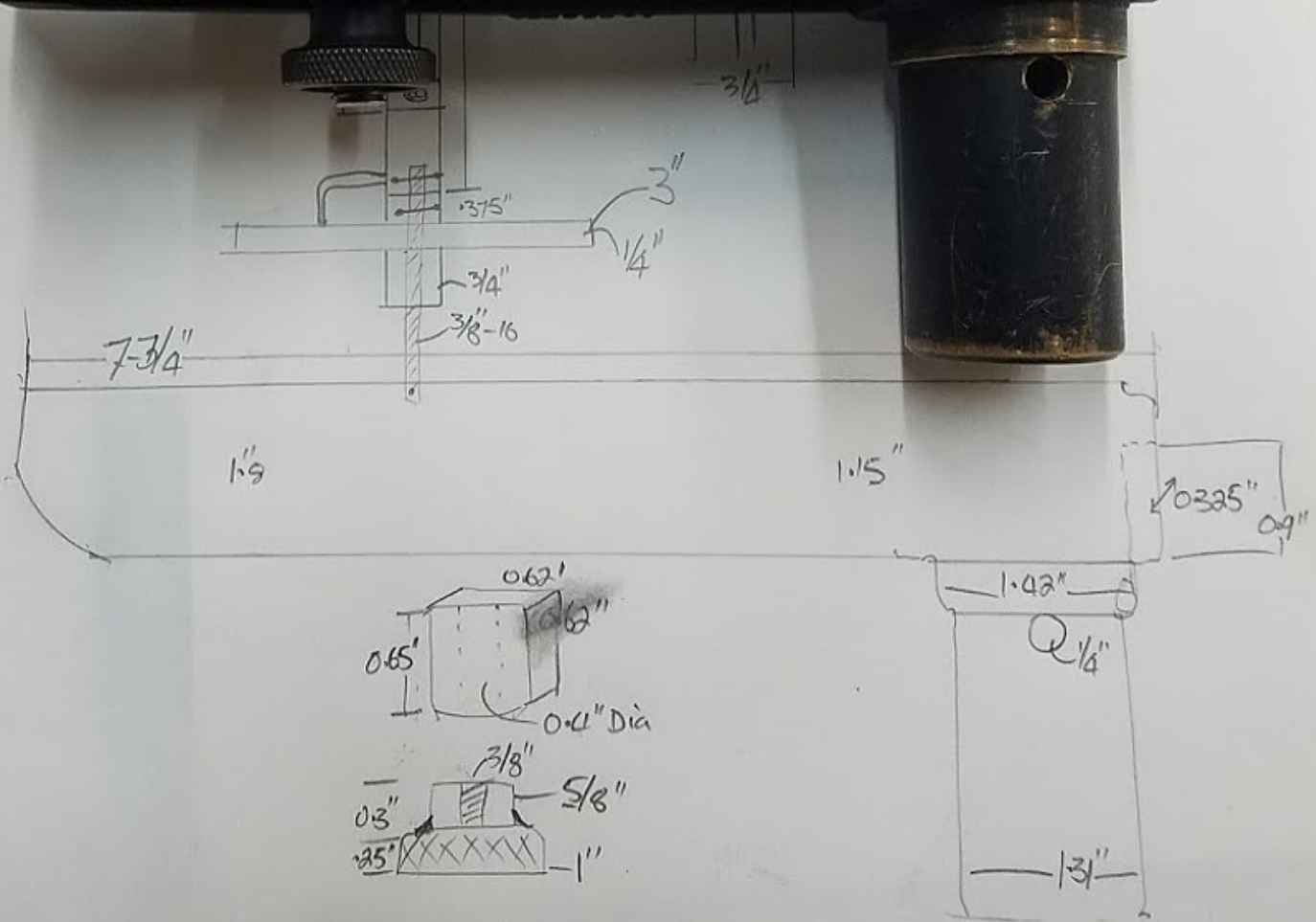
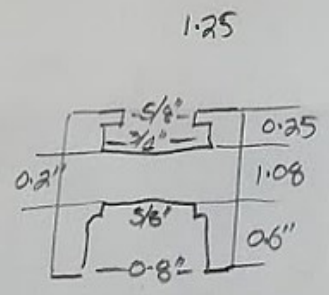



TORPEDO  
AVERAGE SPEED

KNOTS

U.S. NAVY BU. OF ORD.  
**TORPEDO DIRECTOR**  
MADE BY  
INSPECTOR  
NEW YORK

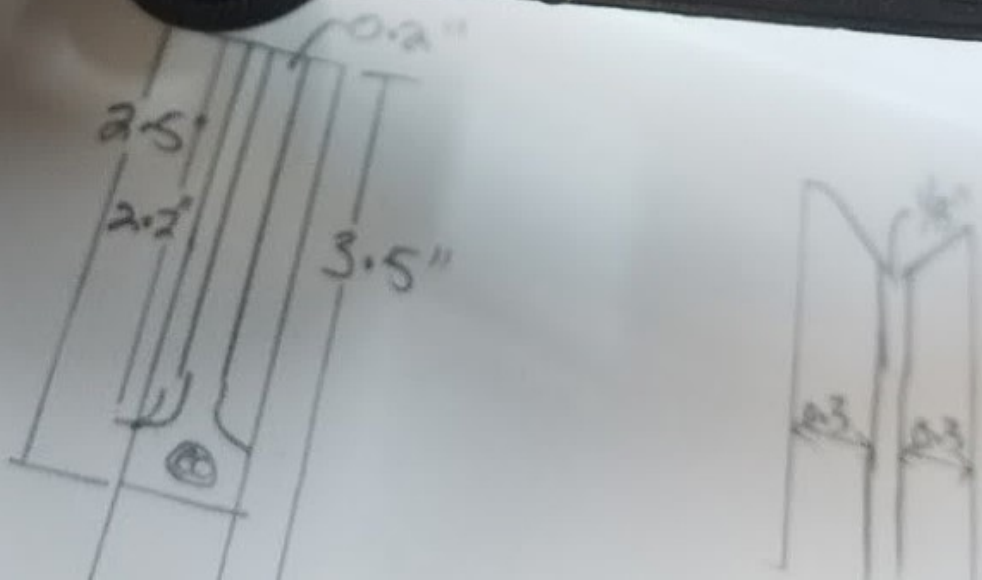

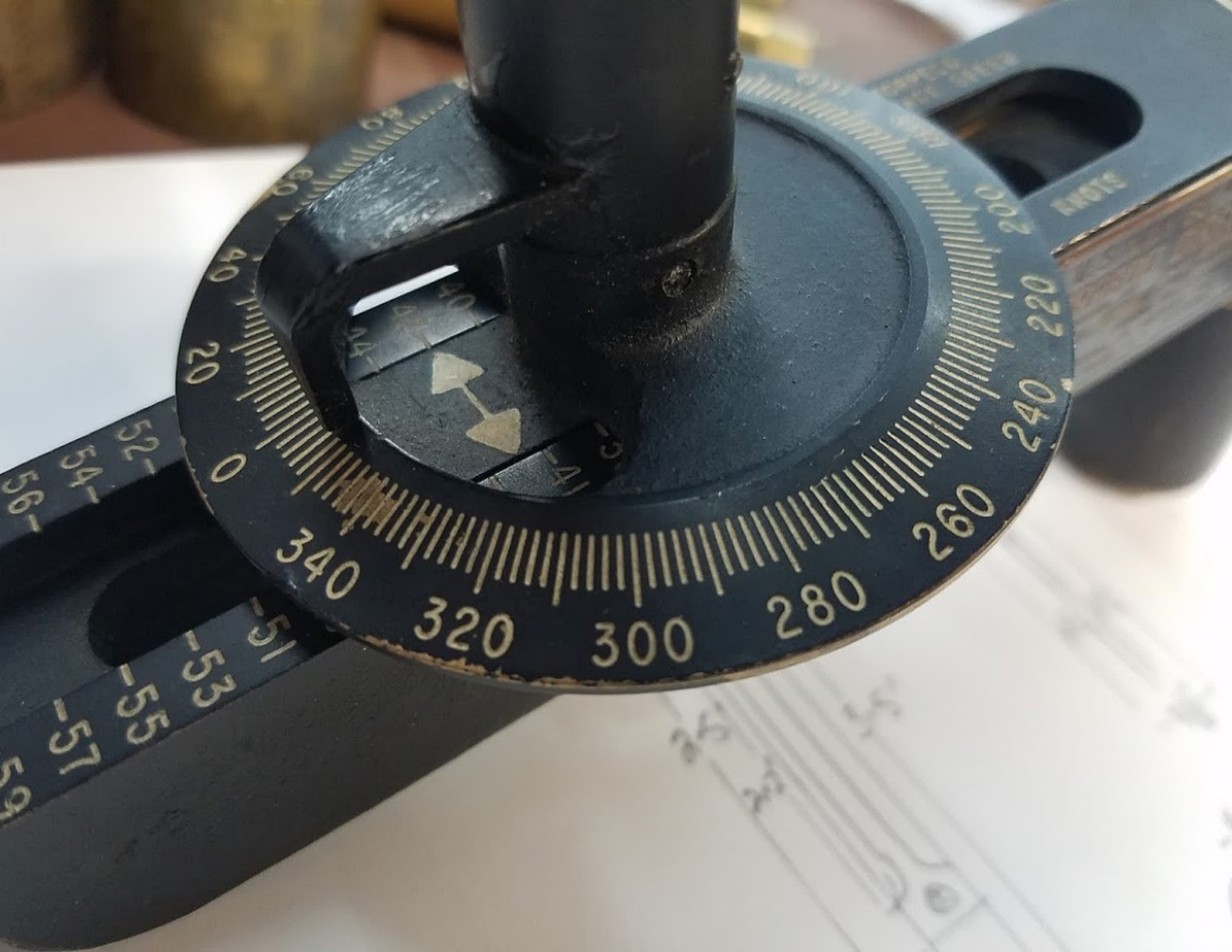

59-  
54-  
52-  
51-  
53-  
55-  
57-  
59-

40  
20  
0

340  
320  
300  
280  
260

200  
220  
240

NOTES

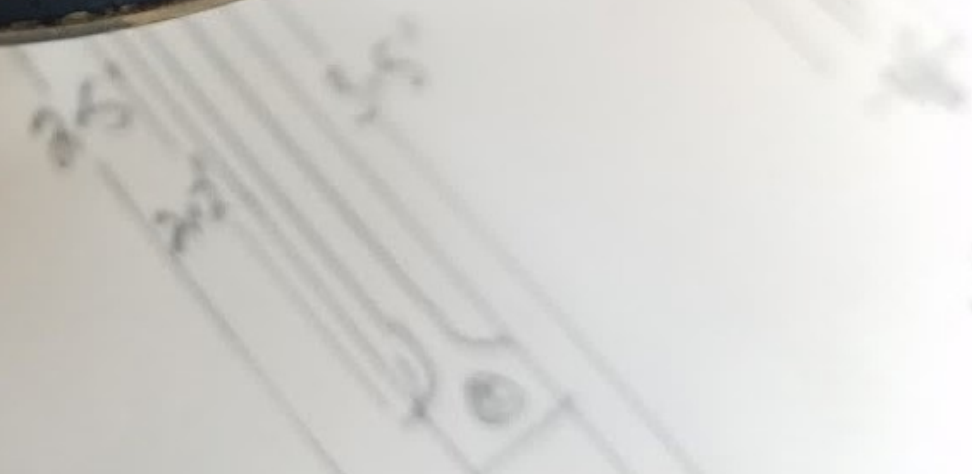

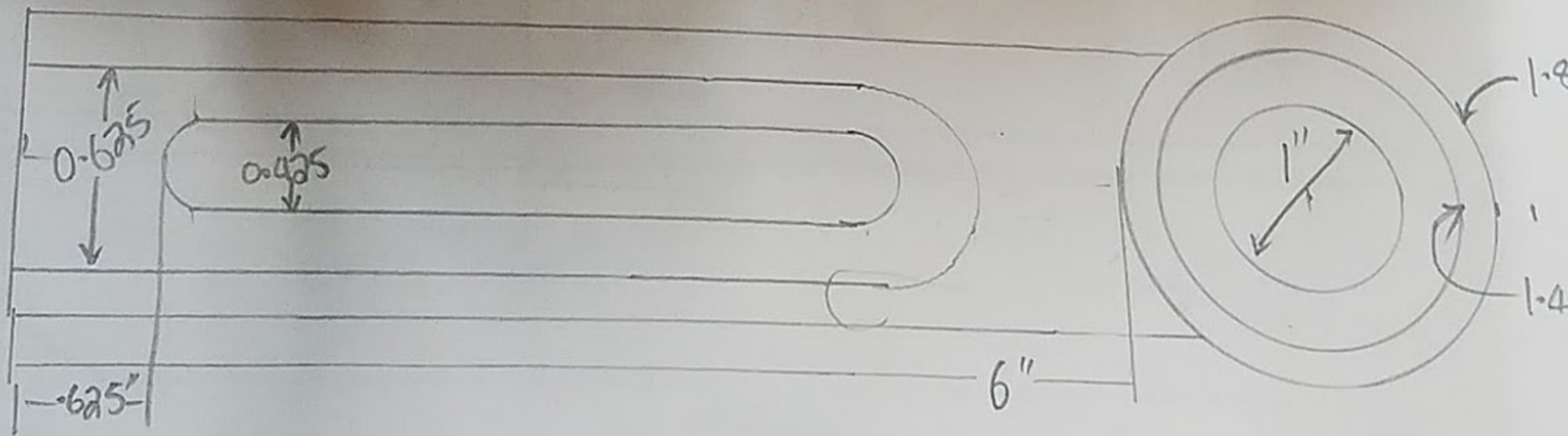
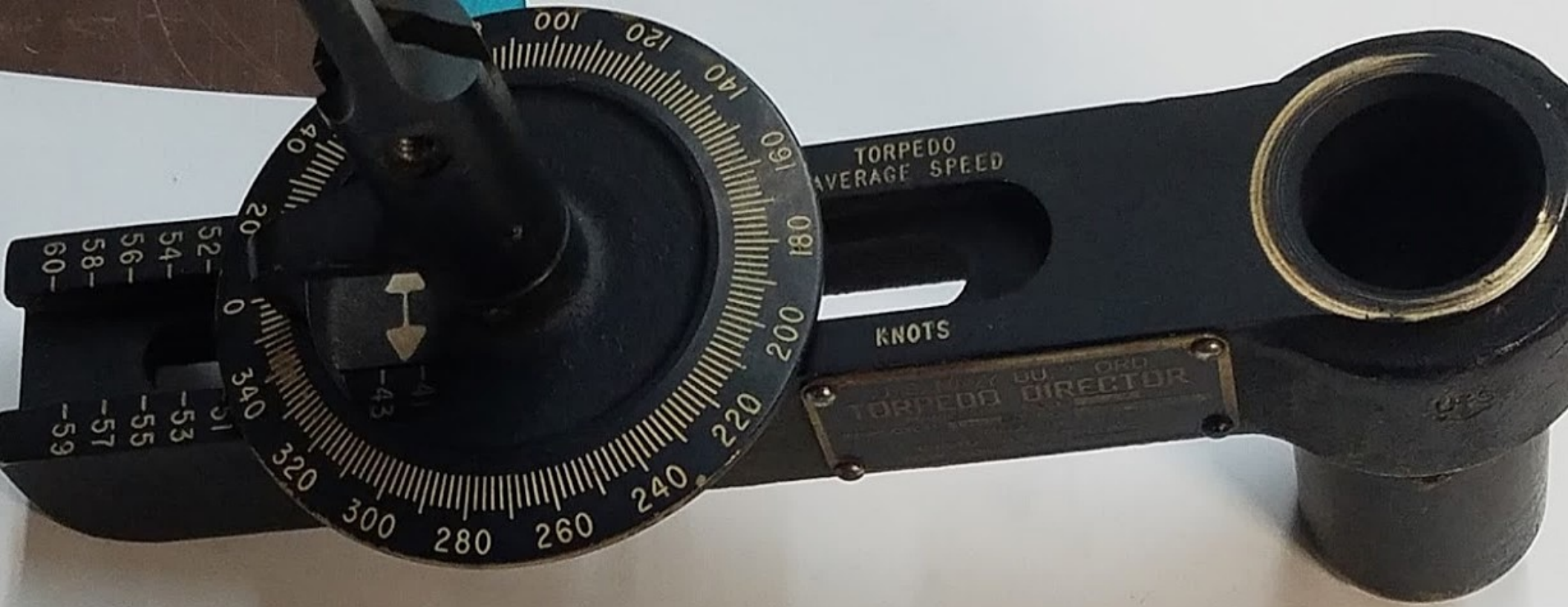



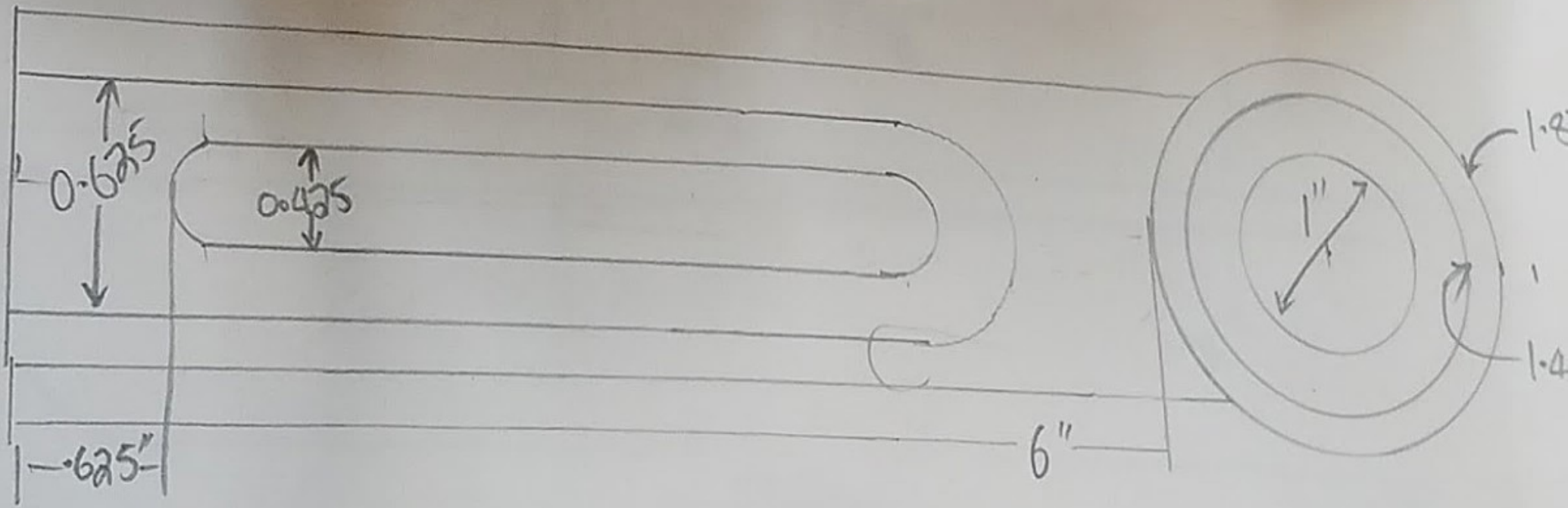
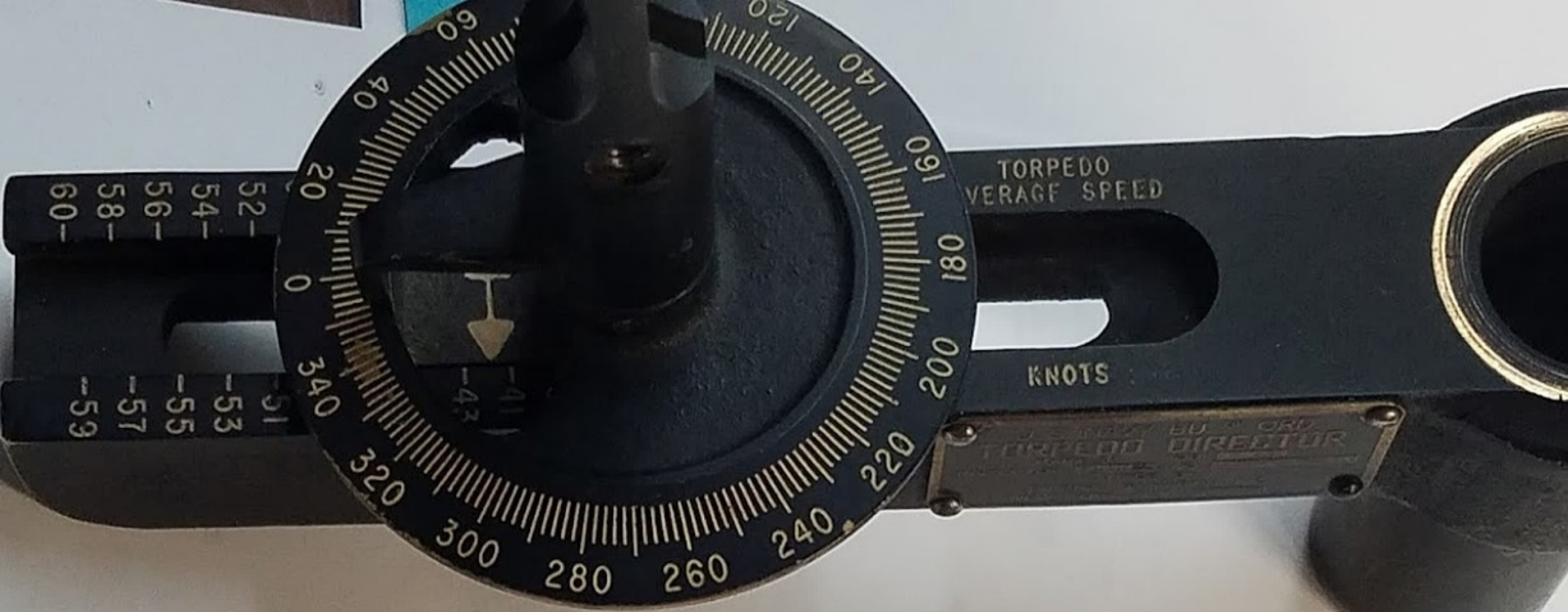

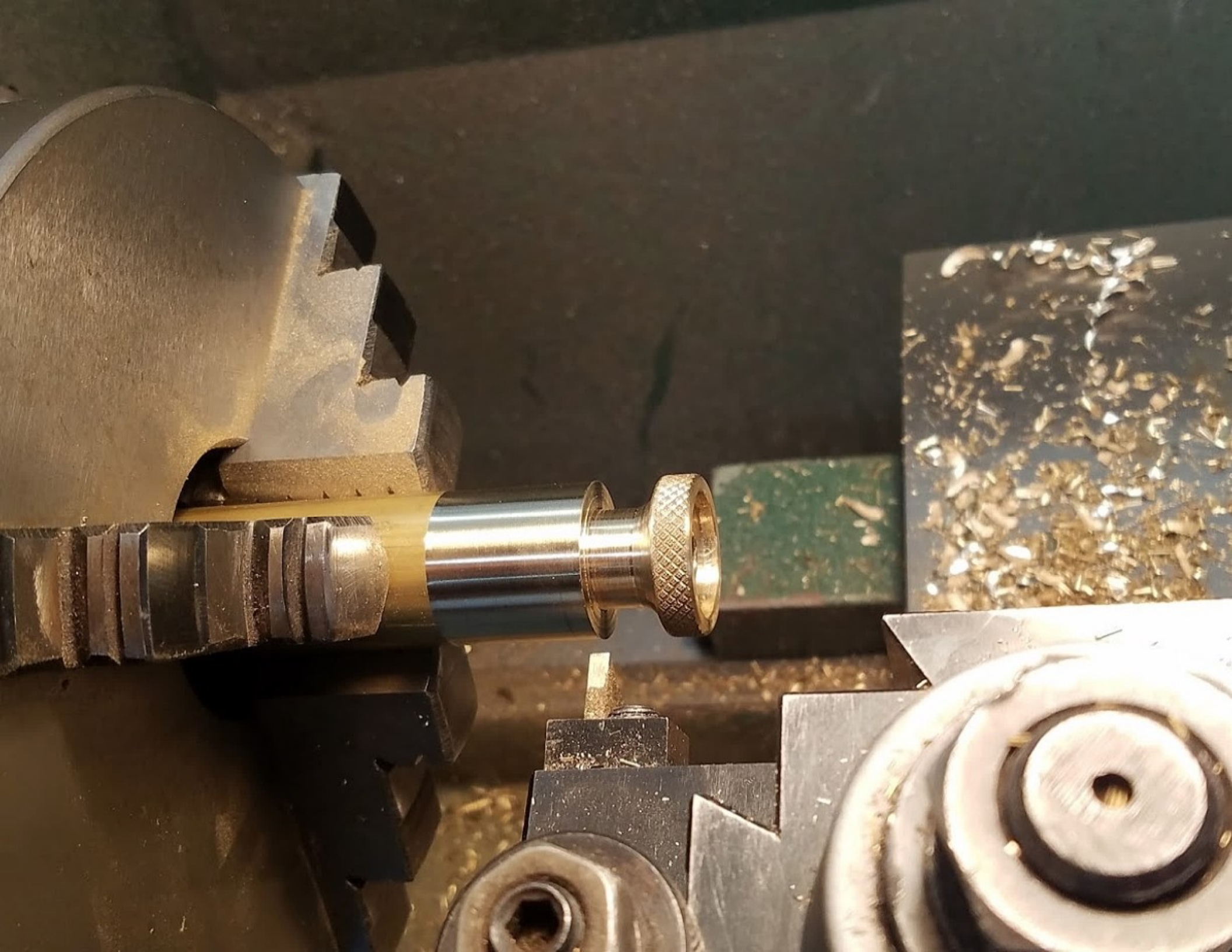

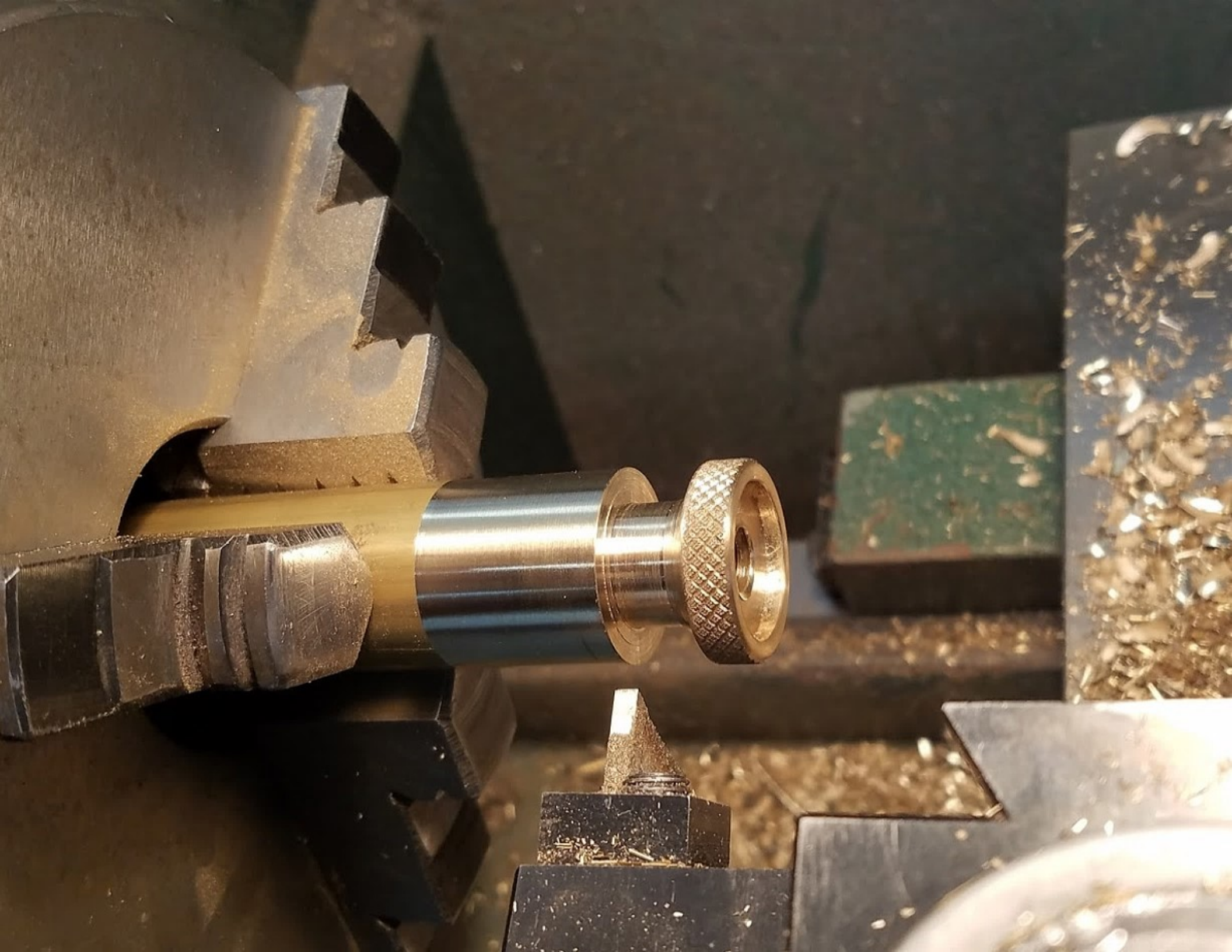

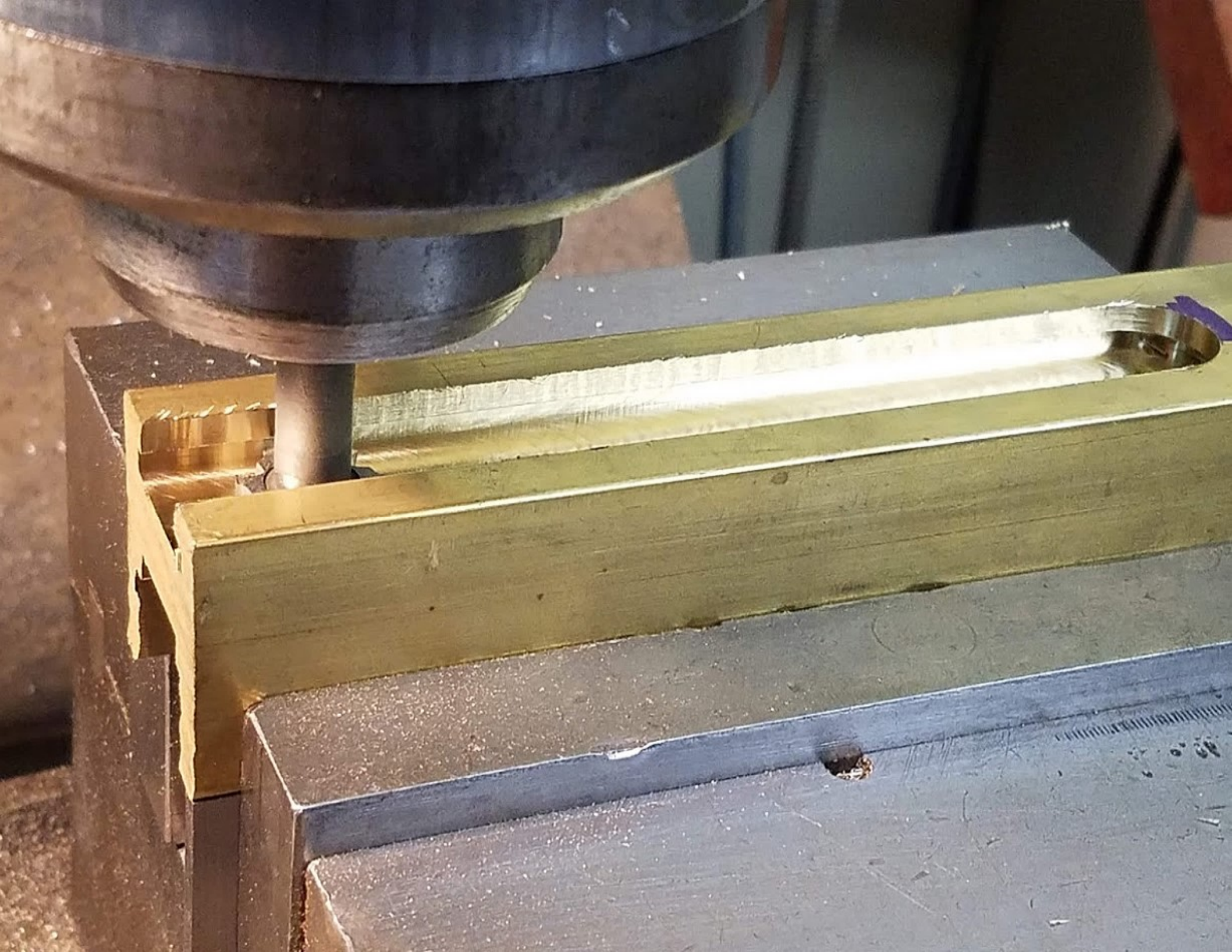







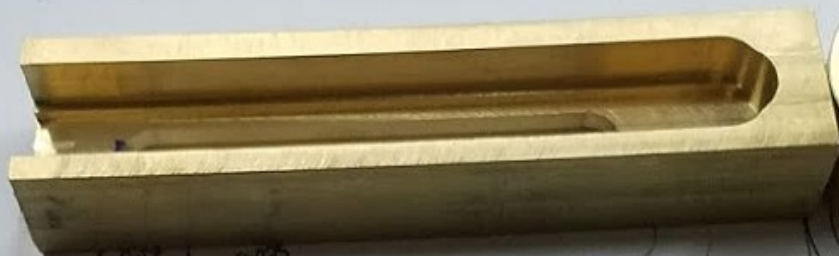

1.5"

1.035"

1.93"



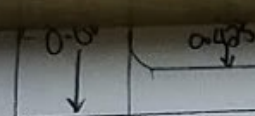
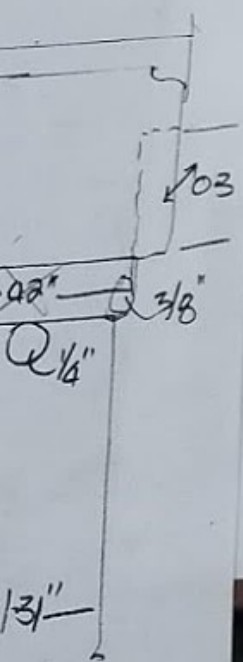



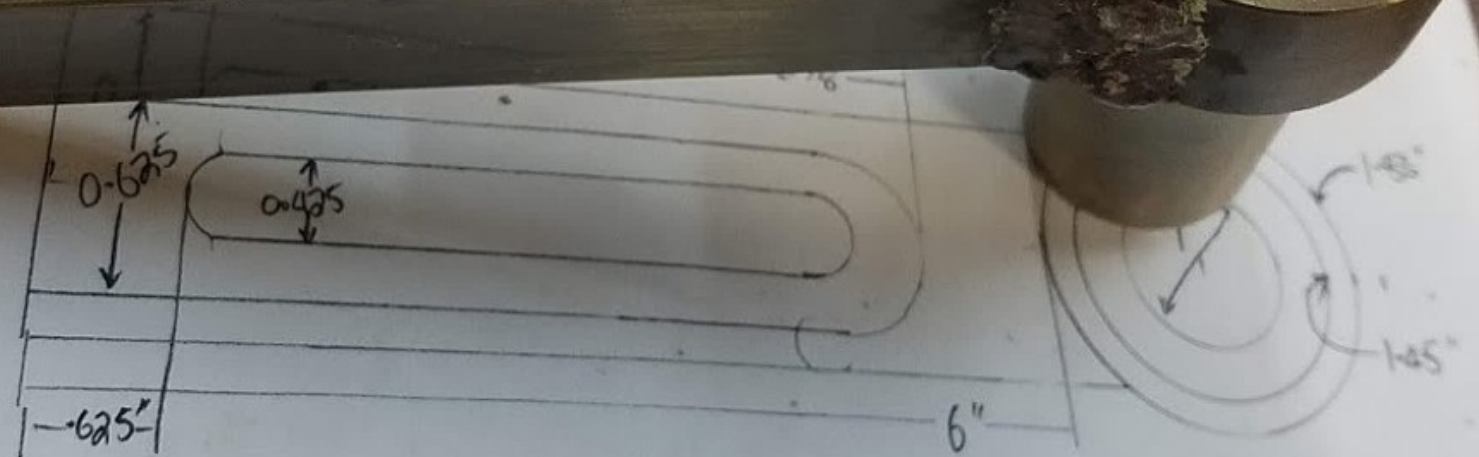









1780 818 0871  
@gmail.com

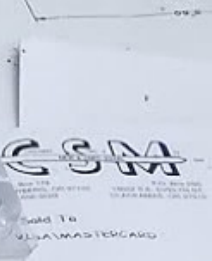



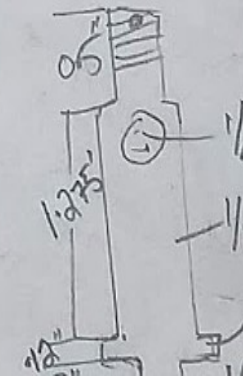
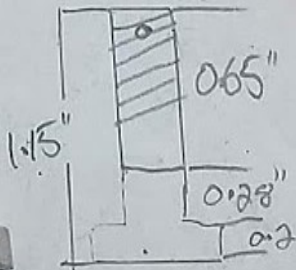
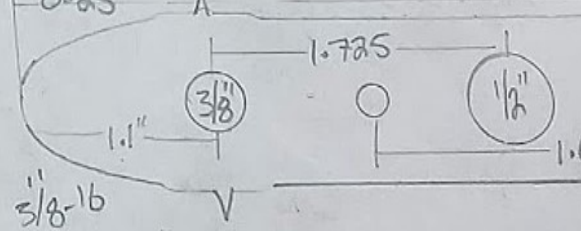
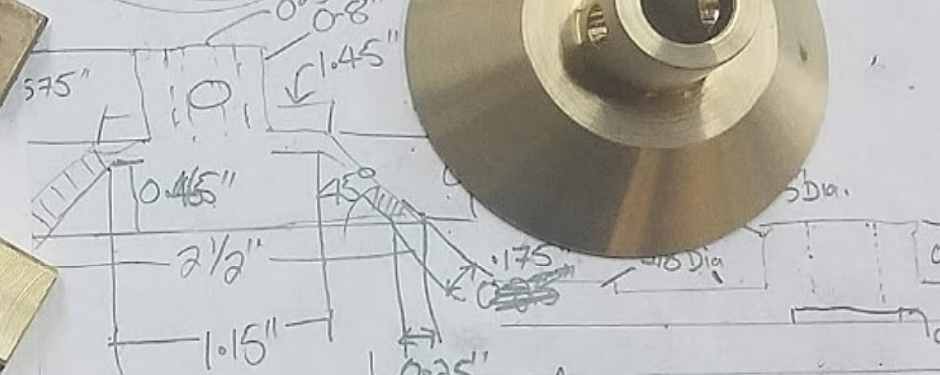
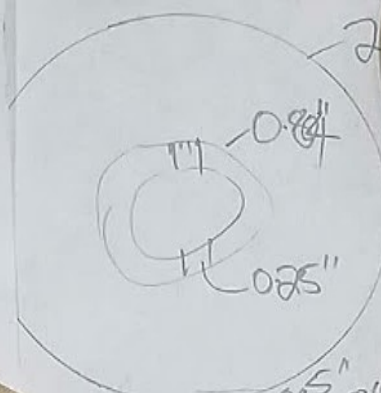
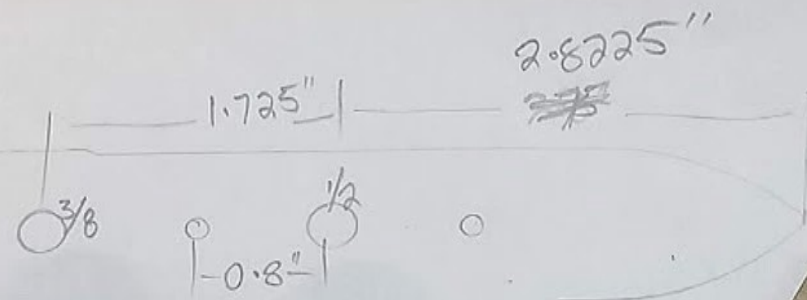

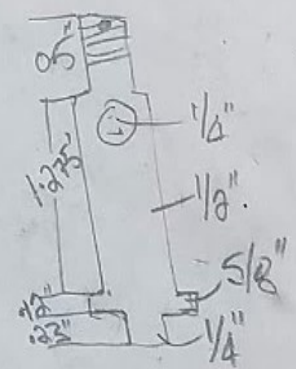
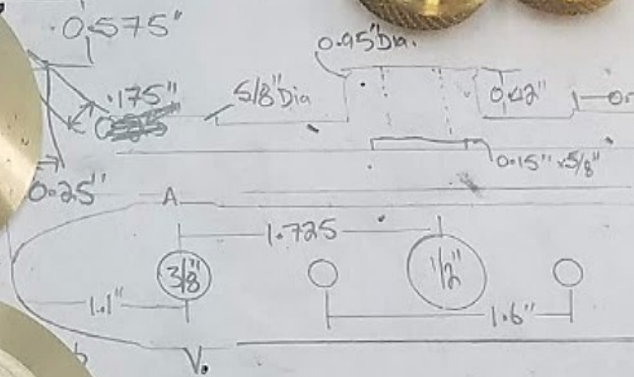
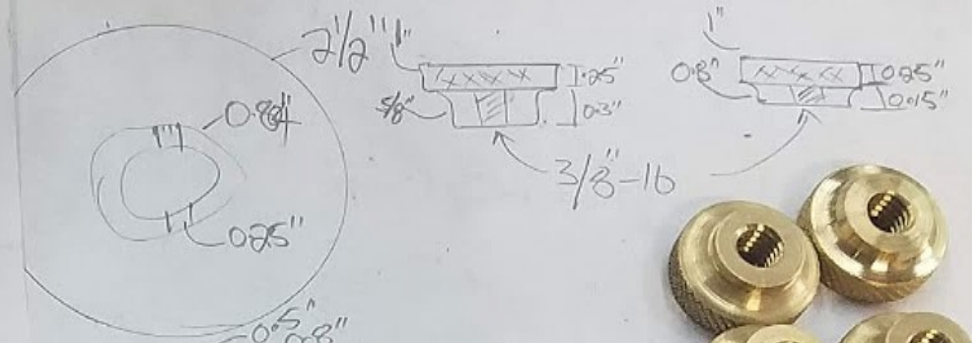
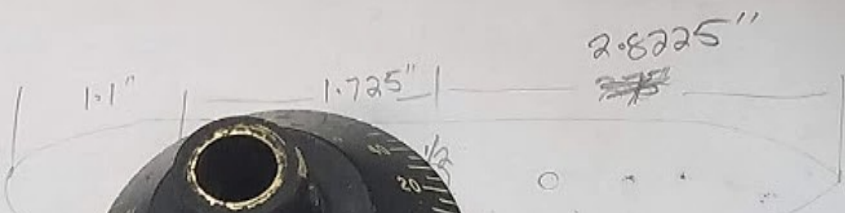

10-32  
BRASS SCREWS

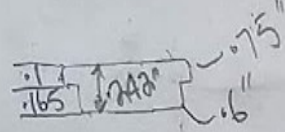
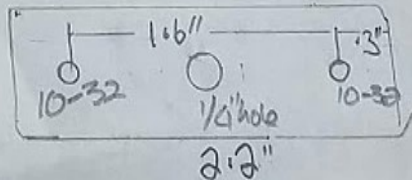



2.8725"  
5/8"

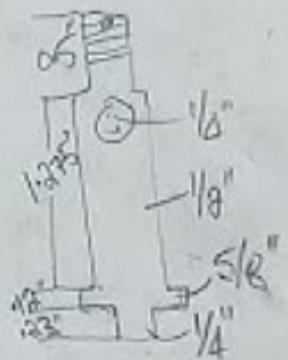
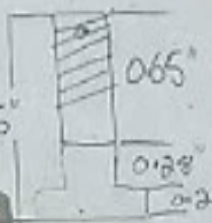
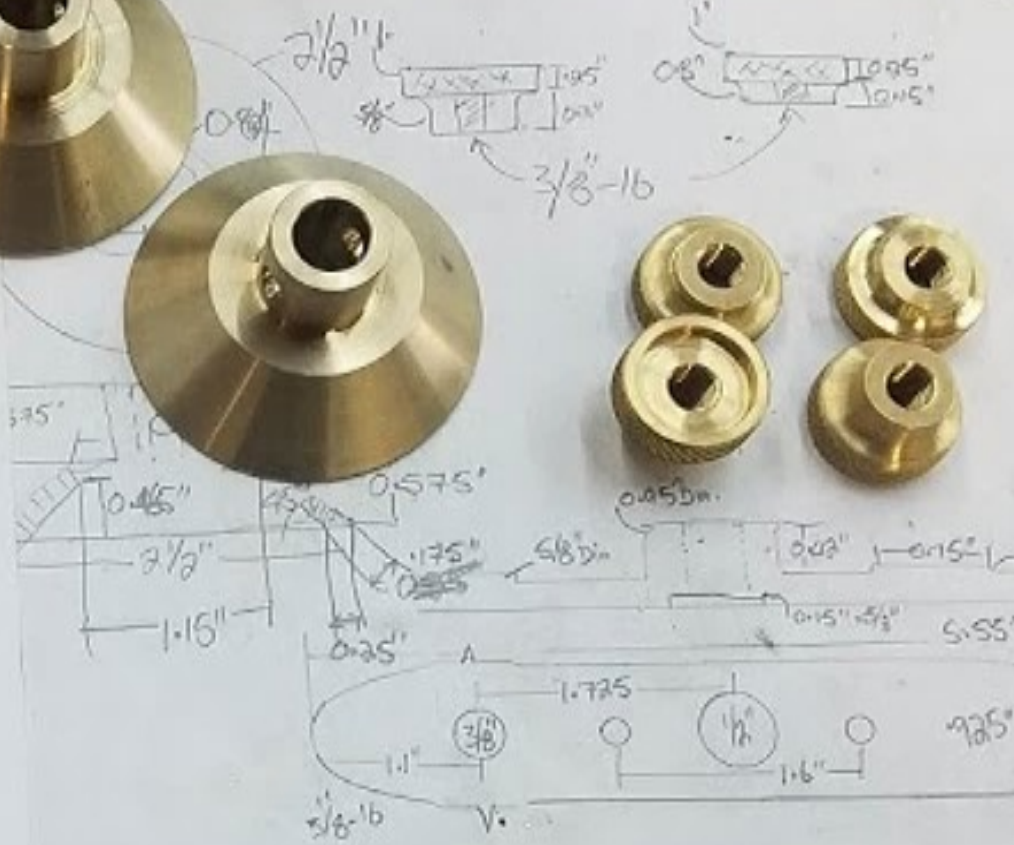

10-32  
Brazed Screws

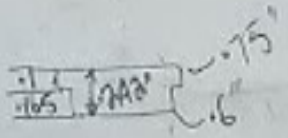
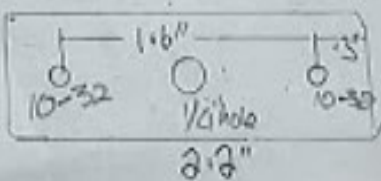

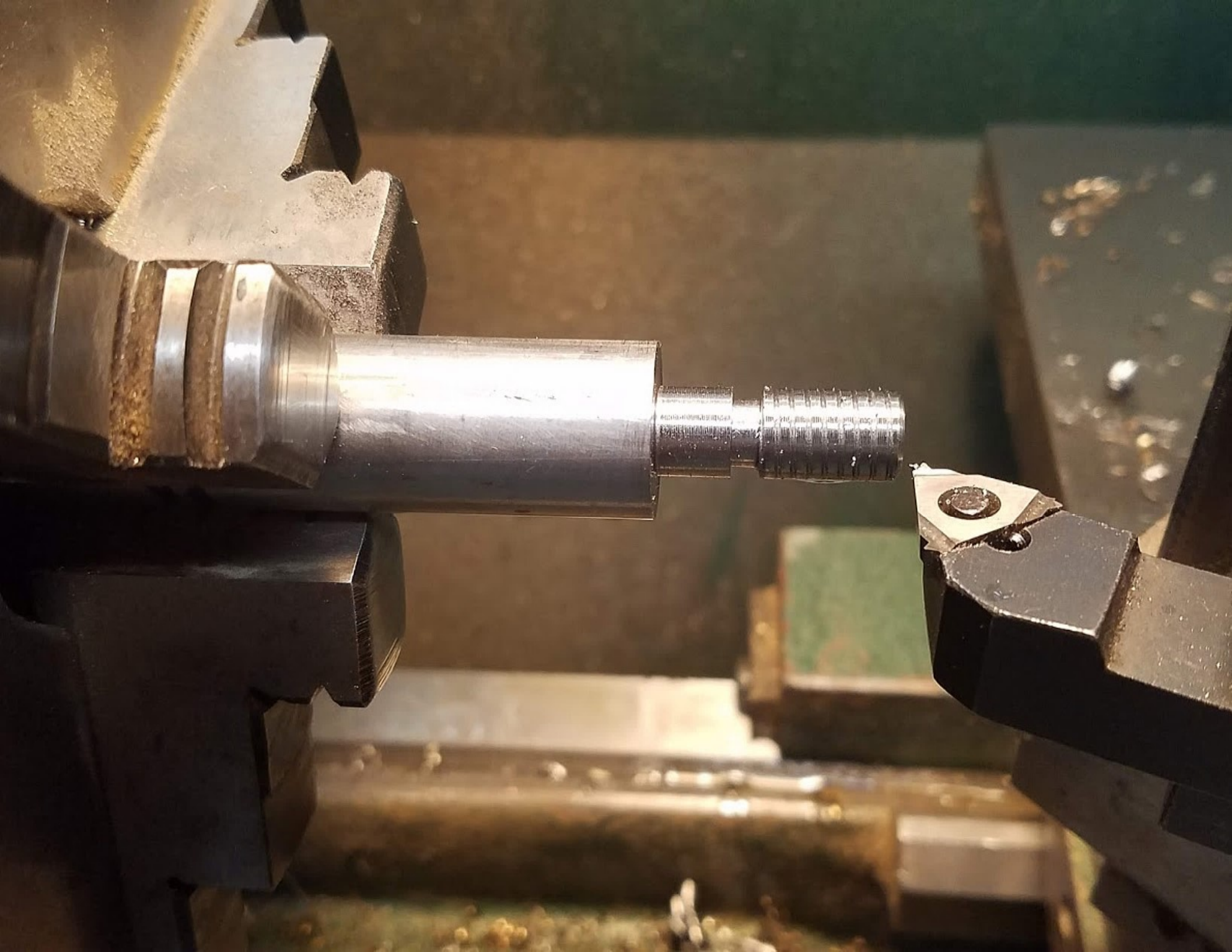

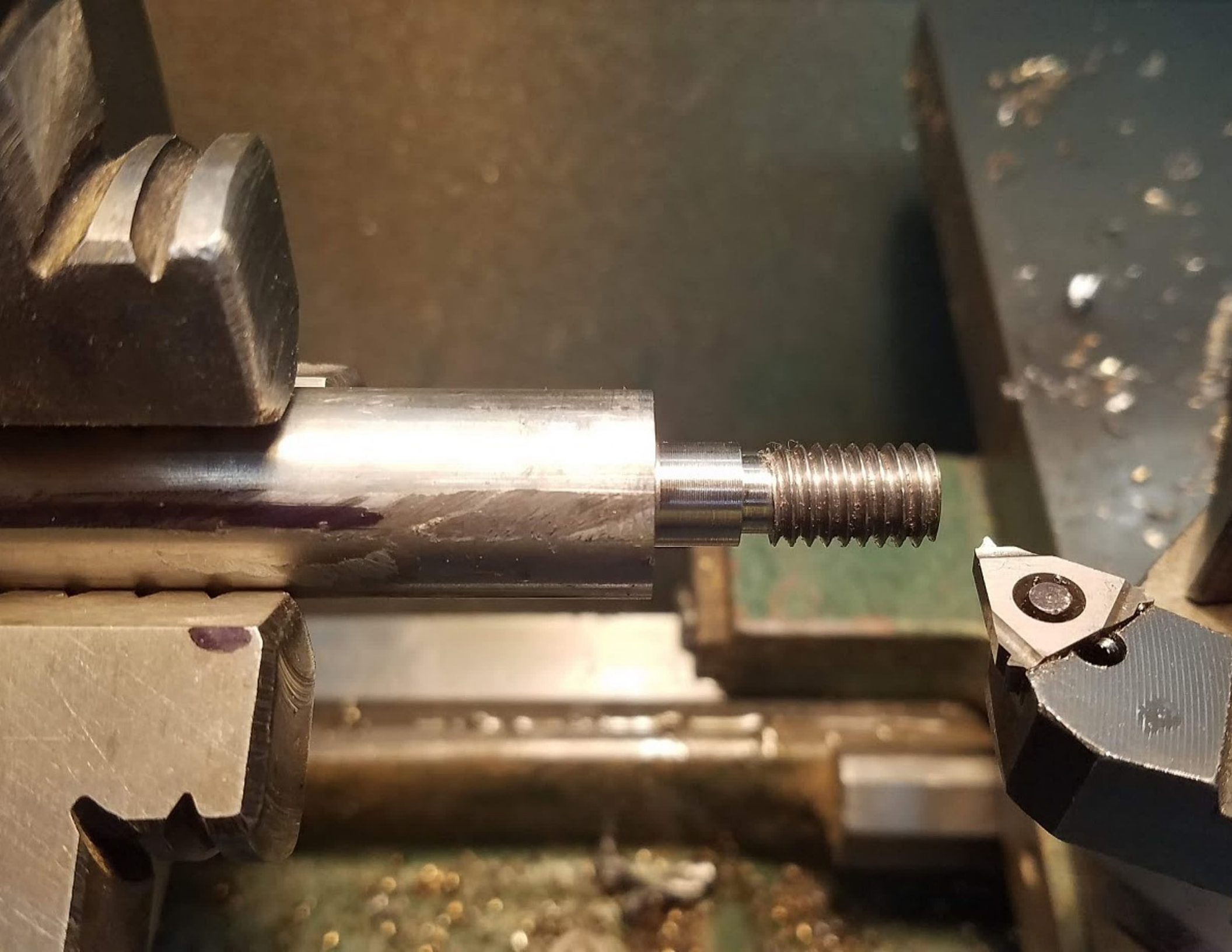





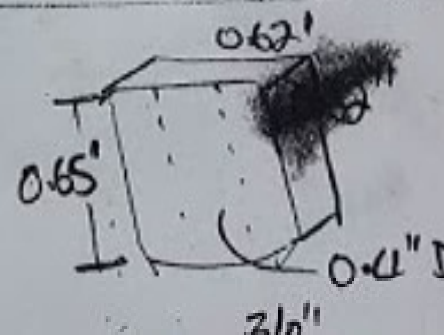
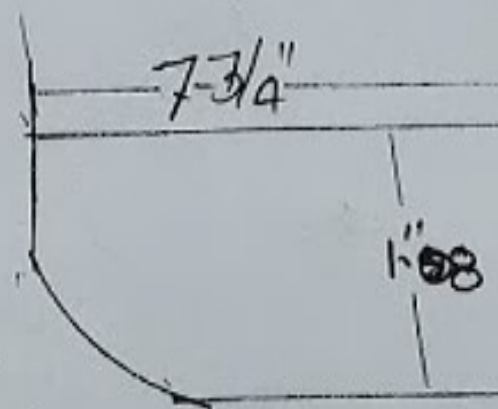
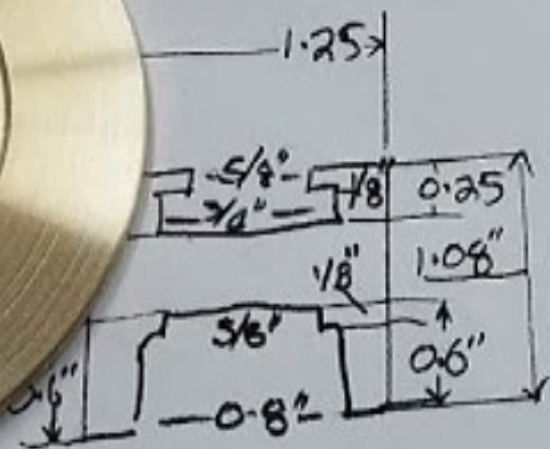
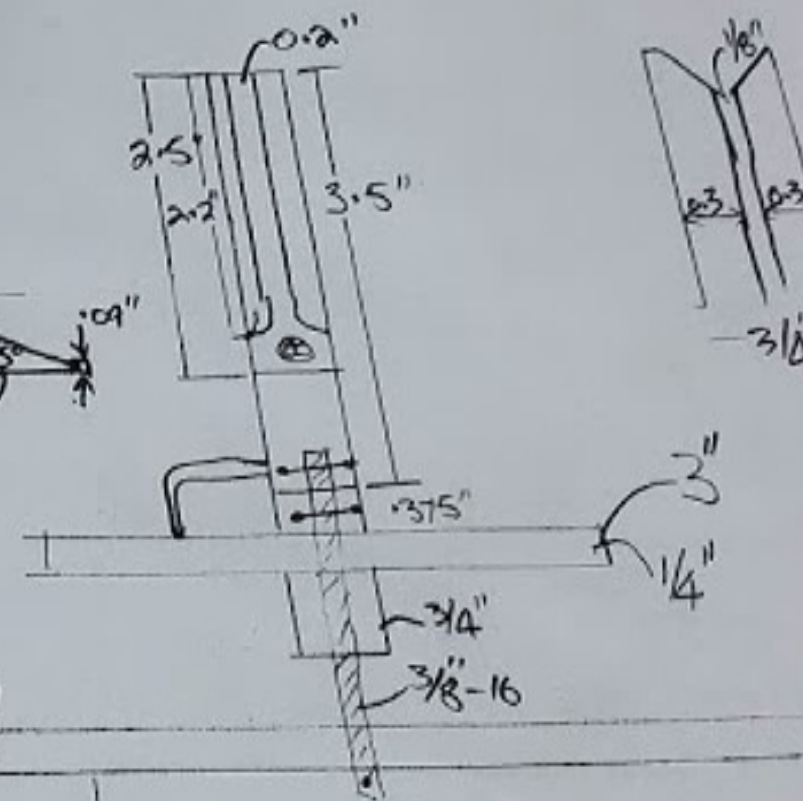
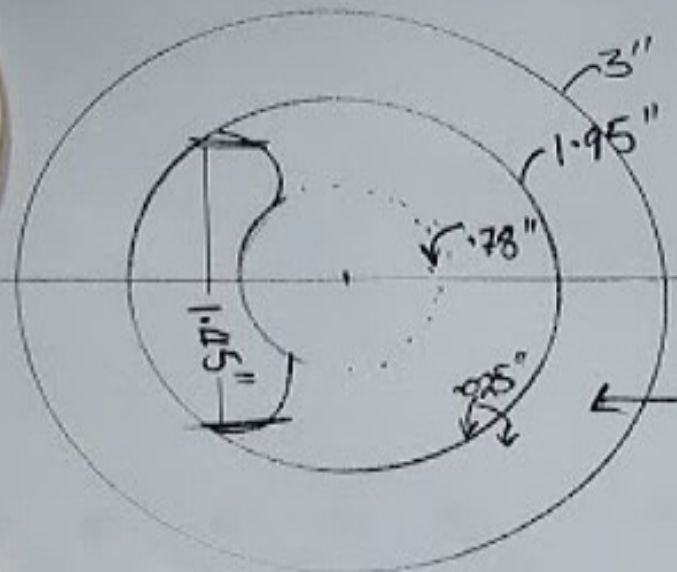







# 8164  
BRASS ROD  
PRECISION METALS  
MADE IN U.S.A.  
K5







fabrications